Operating Experience with Modern High Speed Diesel Engines in Ship Assist Tugs and Related Requirements for Future Engine Development

Sebastian Schwarz, (speaker/co-author), **Brian Case** (co-author), **Dr Claus Schmalzing** (co-author), MTU, Germany

Andrew Packer, (speaker/co-author) MTU-Detroit Diesel, USA

SYNOPSIS

This paper describes the latest operating experience with modern high speed diesel engines in ship assist tug applications up to and beyond 70 tonnes bollard pull. The main aspects covered are the tug operation, mission profile and the derived requirements for the diesel engine, especially the torque characteristics required for rapid load changes due to acceleration and manoeuvring in exposed conditions.

Actual field measurements on various ship assist tugs in the power range up to 6,500hp will be discussed together with the possibilities for utilisation and calibration of engineering tools, such as simulation software and diesel engine test bench for transient operation.

The evolution of the Series 4000 marine engine technology from 1996 to 2009 will be covered, as well as challenges with future emission regulations. Fundamental requirements, such as the lowest operating costs, in the typical operating profile as well as lowest visual emissions, will be considered.

A look ahead towards potentials of an advanced, integrated hybrid concept in regard to further optimisation of the dynamic behaviour as well as fuel economy is also included.

INTRODUCTION

In the commercial marine industry, the life cycle costs of the vessel and its main propulsion and auxiliary engines have always been a key subject. In recent years, the environmental impact and emissions of ships and on board equipment has gained importance, thanks to growing environmental awareness and emission regulations.

However, this positive trend cannot be at the cost of efforts to further improve operating safety, both for the crew on board a vessel and the immediate proximity of the vessel.

The torque reserve and the dynamic behaviour of the main propulsion engine is one of the key factors influencing the vessel response and manoeuvrability. EPA and EU emission regulations specify limits for particulate matter (ie soot) for steady-state operating conditions only. However, black smoke clouds during vessel acceleration are no longer acceptable in public areas eg ports, and must be addressed during engine design. The diesel engine technologies selected for the latest generation of the Series 4000 have been evaluated against: reliability and availability; life cycle costs (invest, operating and maintenance costs); dynamic behaviour/torque; visual (soot) and non-visual emissions in stationary and transient operation; using state-of-the-art engineering tools, comprising simulation software for load steps/acceleration and an advanced diesel engine test bench for transient operation.

The paper closes with a short look forward to the potential of diesel electric or hybrid systems with regard to further optimisation of the dynamic behaviour, in particular low end torque.

1. SELECTED TUG REFERENCES AND CHARACTERISTICS

Ship assist tugs are compact and powerful workboats, typically powered by twin diesel engines with azimuth stern drives (ASD). Typical duties can be summarised as escorting large vessels, guiding them in and out of a harbour, as well as assisting them in the docking process in the harbour or at terminals.

Depending on the activities the tug must undertake, and its area of operation, one of the following propulsors may be selected: conventional twin propellers (fixed pitch propellers [FPP] and controllable pitch propeller [CPP]); cycloidal propellers and Z-drives (also called rudder propellers), with fixed pitch (FP) or variable/controllable pitch propeller (CP).

The tug references chosen all have Z-drives with fixed pitch propeller, as this is the most frequent configuration and the fixed pitch configuration is the most demanding for the diesel engine.

Controllable pitch propellers or slipping clutches offer more operational flexibility ie with several combinator curves for engine speed/propeller pitch

and they offer better protection against engine stalling. For escort tugs, propulsors with controllable pitch propellers (Voith Schneider Propeller [VSP] or rudder propeller with controllable pitch [RP-CP]) are the preferred propulsion concepts.

Moran company profile

Moran operates within three primary areas: ship docking, LNG activities, and general towing, in and around the ports it serves; marine transportation or petroleum and dry bulk products; and contract towing and specialty towing. It owns and operates 96 tugs and 30 barges. To ensure the efficiency and growth of its fleet, an on-going programme of high-tech omnidirectional tug construction is maintained, which we will focus on in this paper¹.

Vessel specification *Laura K, Shiney V*

LOA: 28m

BP: 61 tonnes

Engines: 2x MTU 16V4000M61 – 2,680 bhp @ 1,800 rev/min

Propulsors: Schottel 1215 – FP Z-Drives

Main Function: Assist large freighters with the docking process

Annual Operating Hours: 3,000 hours/year

Home Port: Staten Island, NY, Port Arthur, Texas, respectively.

Seaspan company profile

The Washington Marine Group provides a wide range of marine-related services to the Pacific Northwest, including three shipyards, an intermodal ferry business and a tug and barge transportation company. Its tug and barge transportation company employs ship assist tugs to assist in daily operations and will be our focus in this paper².

Vessel specification *Falcon*

LOA: 24m

BP: 40 tonnes

Engines: 2x MTU 12V4000M60 – 1,770 bhp @ 1,800 rev/min

Propulsors: Niigata Z-peller Model RG140 KY with a Kaplan Propeller

Main Function: Assist large freighters with the docking process

Annual Operating Hours: 3,000 hours/year

Home Port: Vancouver, British Columbia, Canada.

Foss Maritime company profile

Foss Maritime provides a wide range of marine-related services including: marine logistics; bunker and petroleum transportation; LNG terminal operations; project cargo and logistics; ship assist and tanker escort; construction support; lightering and bulk transportation; ocean-, harbour- and river-towing; shipyard services; professional engineering and emergency response, rescue and repair. Its fleet of tugs provides a full range of harbour, ocean and river services, and their shipyard is continually building new

tugs to meet their customers' needs, which we will focus on in this paper³.

Vessel specification *America*

LOA: 29.9m

BP: 81 tonnes

Engines: 2x MTU 16V4000 M71, 3,305 hp @ 2,000rev/min

Propulsors: Niigata ZP-41 Z-Peller

Main Function: Assist large freighters with the docking process

Annual Operating Hours: 3,000 hours/year

For further details refer to *TugWorld Review 2008*.

Remolques Unidos company profile

Founded in 1962, Remolques Unidos provides, with its own fleet; harbour towing services at the port of Santander, high sea towing, escort and salvage, fire-fighting, antipollution, and complementary activities of mooring of ships, auxiliary boats, pontoons etc⁴. Founded in 2001, Rusa Santander, SL (actually titular with Reyser Santander SL), provides harbour towing services at the port of Santander. The fleet consists of more than 25 tugboats, in addition to other auxiliary boats.

Vessel specification *Vehintidos*

LOA: 31,5m

BP: 75 tonnes

Engines: 2x MTU 16V4000M61 - 2,680 bhp @ 1,800 rev/min

Propulsors: Schottel SRP 1515 -FP Z-Drives

Main Function: harbour, high-sea, escort, fire fighting and anti-pollution

Ship assistance in harbour area and escorting to and from harbour and at sea

Annual Operating Hours: 1,500 hours/year

Home Port: Santander, Spain

2. OPERATING EXPERIENCE WITH SELECTED REFERENCES

Rather than using only our interpretation of the typical manoeuvres and requirements of a ship assist tug, industry experts were contacted to answer the following questions:

- What are ship assist tug standard operational manoeuvres?
- What is your diesel engine selection criteria for a ship assist tug?

The experts enlisted were Robert Allan Ltd (Naval Architects and Marine Engineers), Seaspan International Ltd (tug owner/operator) and Moran Towing Corporation (tug owner/operator).

Engine load profiles

The total operating time of the engines varies from less than 1,000 hours to more than 10,000 hours. The engine load profiles for the selected tug boats referenced in Section 1 were exported from the engines' ECU-and were plotted as follows:

- A conventional diagram showing the operating time (percentage of total operating time) on the y-axis versus the engine load (percentage of rated power) on the x-axis;
- A diagram showing the engine performance diagram split into segments (150 rev/min x 75kW) and the related operating time is shown in different colours plus the percentage value. This diagram shows the actual band of operating areas and which operations are dominant. It also allows for differentiation between a 60 per cent load operation, free running (near rated speed) or medium pushing (approximately 1,400-1,500 rev/min).
- Engine power range (< 10 per cent of rated power) – 50.4 per cent of operation time;
- Engine power range (10 per cent < x ≤ 20 per cent of rated engine power) – 19.3 per cent of operation time;
- Engine power range (20 per cent < x ≤ 30 per cent of rated engine power) – 18.9 per cent of operation time;
- Average load factor (total operating hours: 3,586 hours) – 16.8 per cent.

Moran **Shiney V** – 2x 16V4000M61
(see *Figures 4a* and *4b*, at end of paper)

- Engine power range (< 10 per cent of rated power) – 39.8 per cent of operation time;
- Engine power range (10 per cent < x ≤ 20 per cent of rated engine power) – 22.5 per cent of operation time;
- Engine power range (60 per cent < x ≤ 70 per cent of rated engine power) – 13.0 per cent of operation time;
- Average load factor (total operating hours: 601 hours) – 23.9 per cent.

Foss **America** - 2x 16V4000M71
(see *Figures 5a* and *5b*, at end of paper)

- Engine power range (< 10 per cent of rated power) – 55.8 per cent of operation time;
- Engine power range (20 per cent < x ≤ 30 per cent of rated engine power) – 20.7 per cent of operation time;
- Engine power range (10 per cent < x ≤ 20 per cent of rated engine power) – 14.7 per cent of operation time;
- Average load factor (total operating hours: 3313 hours) – 14.1 per cent.

FiFi pump operation with a very unique power demand curve might be identified in this diagram, provided that the main power take off is de-clutched from the main engine during FiFi operation.

General observations

Although every tug has a particular mission and area of operation the following general observations can be made:

- High engine load (> 70 per cent of rated engine power) occurred only 4 per cent of the time and less than 1 per cent of the time at > 90 per cent of rated engine power;
- Low engine load (< 10 per cent of rated engine power) is clearly dominating, with more than 50 per cent of its total time for two of the tug boats evaluated in this report;
- The wide band of power demand at a given engine speed results from the different conditions free-running to bollard pull (stationary) and from the high degree of transient operation, manoeuvring and acceleration.

Particular observations

Seaspan **Falcon** – 2x 12V4000M60
(see *Figures 1a* and *1b* at end of paper)

- Engine power range (10 per cent < x ≤ 20 per cent of rated engine power) - 36.6 per cent of operation time;
- Engine power range (< 10 per cent of rated engine power) – 25.3 per cent of operation time;
- Average load factor (total operating hours: 10050 hours) – 22.7 per cent.

Rusa **Vehintidos** – 2x 16V4000M61
(see *Figures 2a* and *2b*, at end of paper)

- Engine power range (< 10 per cent of rated engine power) – 35.8 per cent of operation time;
- Engine power range (40 per cent < x ≤ 50 per cent of rated engine power) – 31.5 per cent of operation time;
- Average load factor (total operating hours: 860 hours) – 24.8 per cent.

Moran **Laura K** – 2x 16V4000M61
(see *Figures 3a* and *3b*, at end of paper)

SUMMARY OF INTERVIEWS

Below are responses to the given question, “What is the standard operational manoeuvre your ship assist tugs must be able to perform?”.

Moran^{5,6}:

“I am not sure if there is a standard manoeuvre that a ship assist tug performs. Every captain/pilot has a great influence on how a tug performs since they all handle the vessel differently. Some are more demanding or harder on the equipment than others. Some are more attentive to what rapid drive position change can cause and know how to prevent engine bog-down, stalling, or placing the vessel and crew in harm’s way. Others learn through mistakes (engine stalls, vessel roll etc). Since the drives have the ability to turn 360 degrees independently, the tug must perform within the abilities of the power plant to increase or maintain rev/min under any condition.

The transverse arrest manoeuvre appears to be the ‘worst case’ scenario since the drives can act as a water brake. This condition, if not monitored properly

could cause one or both engines to bog down or stall. An engine needs to be able to provide pulling power from idle to rated engine power with minimal delay. One scenario that came as a surprise was when it was reported that **Shiney V Moran** had both engines stall during a ship assist. Interviews with the captain revealed that a ship assist tug will meet a ship that is under way with as much of 10 knots of speed. The tug will tie up to the ship and will allow itself to be dragged until it is requested to provide pulling assistance. If the engines are allowed to remain at idle (600 rev/min request throttle), the flow of water through the drives at 10 knots is enough to motor the engines. It was observed that the engine speed was 680 rev/min with a throttle request speed of 600 rev/min. This causes the engine control unit (ECU) to go to '0' fuel for as long as the actual engine speed is greater than the throttle request input.

We were told that this dragging scenario is common and the drag could occur for a few minutes to more than an hour. This all depends on the terminal, port or type of assist requested. In this particular scenario, the vessel was dragged for 45 minutes before they were asked to provide pulling assistance. When the captain rotated the drives, the engine speed was zero. However, the engine restarted immediately and no harm was caused. This scenario was duplicated by tying up alongside of another tug and moving at 10 knots, where the 'motor effect' and no fuel request from the ECU was observed.

One way to prevent this condition is to provide a throttle input speed greater than the motoring speed. A concern in this scenario is the longer the engine is motored without a fuel request, the cooler the exhaust and cooling system will become. It is possible that the coolant temperatures could drop below recommended operating values (ie < below 140 degrees F). Consideration should be given to display an alarm if the engine is ever in this condition for a short period of time, allowing the operator to react accordingly. In summary, if an operator wants to stall an engine, they will. There are many scenarios that have the potential to place the engines into a manoeuvre that can cause the engine to bog down or stall. This is true with engines from any manufacturer."

Seaspan⁷:

"Predominantly the vessels are used in two locations for ship assist purposes:

1. Vancouver Harbour, container ships, grain, lumber, coal, sulphur, etc;
2. Delta Port, containers and coal.

The **Seaspan Falcon** profile indicates, on average, that these engines operate 36 per cent of the time at 10-20 per cent load. However, Seaspan charges the customer a fee based on available engine horsepower, therefore it is charged for whether or not it is used. If the pilot gets into trouble, the power must be available because they are paying for it. Seaspan is looking at diesel electric for this reason.

They must be able to position or correct their position while connected to the container vessel by a single line from the bow winch. The ability for the vessel to move in any direction quickly is paramount. The angle of attack on the bow line is used to slow the vessel in most cases while berthing and to move the vessel away from the dock when the container ship is leaving port."

Robert Allan Ltd^{8,9}:

"There is no such thing as Standard Operational Manoeuvres. These are high performance vessels in the hands of skilled operators and the operational manoeuvres are limited only by the imagination and skill of the operator. One important application is when a tug with fixed pitch propellers (no slipping clutch) is assisting a ship and is effectively being towed by the ship. In this application reverse water flow through the propellers can cause acceleration issues. The reverse flow shifts the propeller demand curve to the left or closer to the max power curve. For a tug to provide assistance to a larger ship it needs to be able to provide thrust quickly, and with reverse flow through the propellers, tugs need engines with good low rev/min reserve power. These issues of course can also be solved with controllable pitch propellers or a full-rated power slipping clutch, but some operators do not like these solutions."

As noted from the responses given, there are a number of manoeuvres used in the operation of ship assist tug boats that generate higher engine loads and require a satisfactory performance and transient response. This is not only for owner or operator satisfaction, but also to a certain degree, safety. For example, when a tug boat is working between the assisted ship and the dock, it is clearly advantageous to have the engines respond to commands with as little delay as possible. Some of the given high-load manoeuvres that engine manufacturers must account for are:

- Partial or full bollard pull/push;
- Transverse arrest;
- Reverse drive orientation.

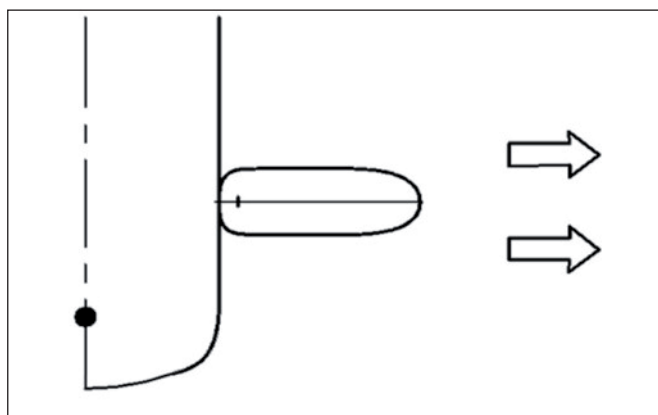

Figure 6: Typical bollard condition.

Bollard conditions (see Figure 6 above) are when the tug boat is pushing/pulling at or near zero

boat speed. This condition is typical when the tug is beginning its initial assist of a ship or when holding a ship in a fixed position ie against the dock while shore lines are being put in place.

These zero speed conditions generate a higher propeller load than when the tug is in motion or running in a non-assist mode, free running. In the engine performance diagram for 16V4000M61 (Figure 7), typical load curves for bollard pull and free running conditions are shown.

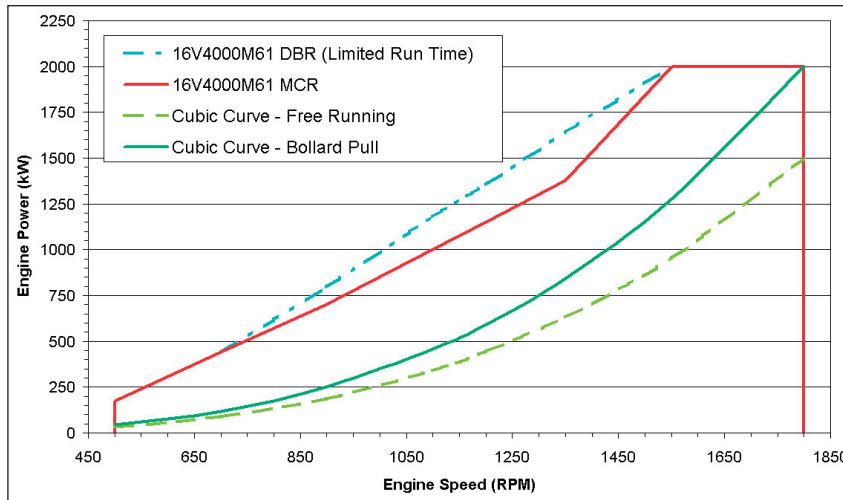

Figure 7: 16V4000M61 performance diagram with load curves BP & free running.

The latter two manoeuvres, transverse arrest and reverse drive orientation, are possible with the now more common azimuth stern drive (ASD) tugs.

Transverse arrest

Figure 8 shows when the tug is in motion and the drive propellers are oriented perpendicular to the direction of travel. This has the effect of slowing the tug and consequently the vessel it is assisting. The engine loads seen during this manoeuvre mimic very closely that of bollard conditions shown above. However, operators must be conscious to bring the engine speed of both engines up equally.

If one engine is accelerated too far ahead of the other, the lead engine will draw in water through the opposite propeller greatly increasing the load on that propeller and propulsion engine. This could lead to a situation where the lagging engine is brought to full load at a lower rev/min and is thus unable to accelerate or stall the engine all together.

Summary of characteristics of transverse arrest:

- Can create up to 1.6 times bollard pull at 10 Effect decreases as the ship speed decreases;
- Less chance of stalling main engines (compared to reverse drive described below);
- Tug remains stable during operation;
- Causes severe vibration on tug;
- Very demanding on machinery.

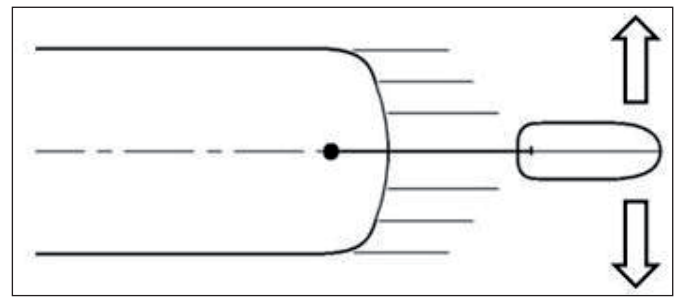

Figure 8: Transverse arrest manoeuvre.

Reverse Drive Orientation

Figure 9 shows how the drive propellers are oriented opposite the direction of the vessel. This is typically seen when the tug is being dragged by a larger vessel and the operator chooses to use this drive orientation rather than the transverse arrest to stop the vessel. From an engine load standpoint, this manoeuvre is rather demanding, especially if the operator is not familiar with the effect on engine load. If, in the given situation described by Moran above, the operator leaves the drives oriented for forward propulsion while being dragged by the larger ship, it will have the effect of motoring the diesel engine.

That is, the diesel engine is being driven faster than its requested speed, by the propellers through the driveline.

As the operator is given the request from the pilot or ship captain to apply braking force, the operator can (even while the engines are still in idle) turn the drives 180 degrees against the direction of travel waiting for the command to add power. The negative water speed seen by the propellers generates more load than zero speed. This means that the engine must use more available power to maintain its current engine speed, in this case idle, and thus has less margin for acceleration.

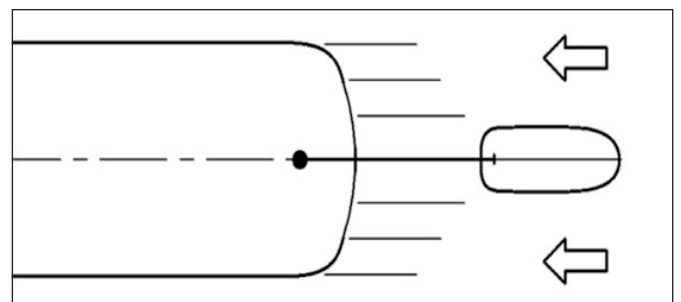

Figure 9: Reverse drive manoeuvre.

Summary of characteristics of Reverse Drive Orientation:

- Direct pull manoeuvre used to stop vessels;
- Uses full bollard pull of the tug;
- No hull hydrodynamic effects;
- Hard to control, tug may have a tendency to oscillate;

- Negative flow through the propellers;
- High propeller vibration;
- Very demanding on machinery.

In the centre of *Figure 10* (60 second mark), the boat is operating with the propulsion drives oriented for forward propulsion as it is being dragged by another ship. One can see that the engine speed commanded by the engine governor is 600rev/min (idle engine speed for this ship), but the engine speed itself is actually running at 661rev/min.

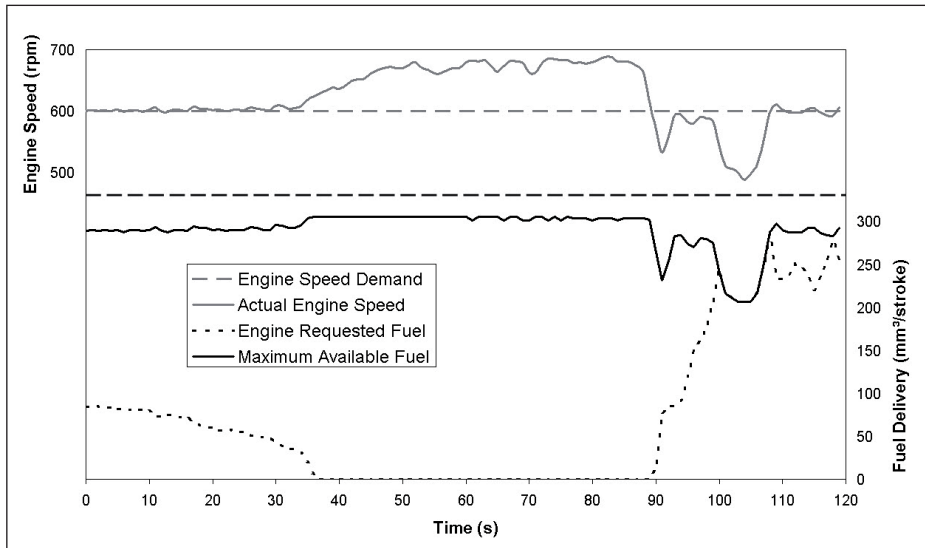

Figure 10: The effect of engine load during a reverse drive orientation manoeuvre. The graph is created from a software interface between the diesel engine governor and laptop computer.

Also notice that the requested fuel quantity is at zero. This shows us that the engine is actually being motored by the propellers and injecting zero fuel. This does not have a negative long-term affect on engine durability. However, it can greatly reduce exhaust gas temperature and coolant temperature, which can have some

operational impact. Further information on exhaust gas temperature follows at the end of this section.

Following the lower dotted line (requested fuel quantity) one can see the effect of fuel quantity as the operator rotates the drives 180 degrees. The demand for higher fuel quantity is the effect of the engine responding to higher loads. At the 100-second mark, the tug has the drives oriented directly against the direction of travel. What is critical here is that the requested fuel quantity, the quantity of fuel the engine needs to maintain its given speed, is very close to the maximum fuel quantity, the maximum amount of fuel that the engine is capable of safely delivering at that given engine speed. The difference between these two values is the margin the engine has left for acceleration.

Graphically shown, it is the margin between the power demand curve and engine power curve, which are illustrated in *Figure 11* (below). Thus when the difference between these two values is reduced, so is the acceleration potential for the engine. In this particular case, the operator has lost over 2.5

times acceleration potential, compared to the propellers seeing zero water speed. This will greatly increase the time needed for the engines to accelerate and generate power for the tug to make braking force when called upon to do so. It is much preferred to bring the drives into the transverse arrest (perpendicular) position, begin accelerating the engines (equally) and then, if desired, orient them in opposition to the direction of travel.

It should be noted that this is not a limitation of engine design and performance. Great efforts are made to maximise the amount of available low-end torque for this exact purpose. Comparisons of high speed diesels per cent torque versus per cent engine speed are very comparable to even their higher displacement medium speed counterparts, some are even better.

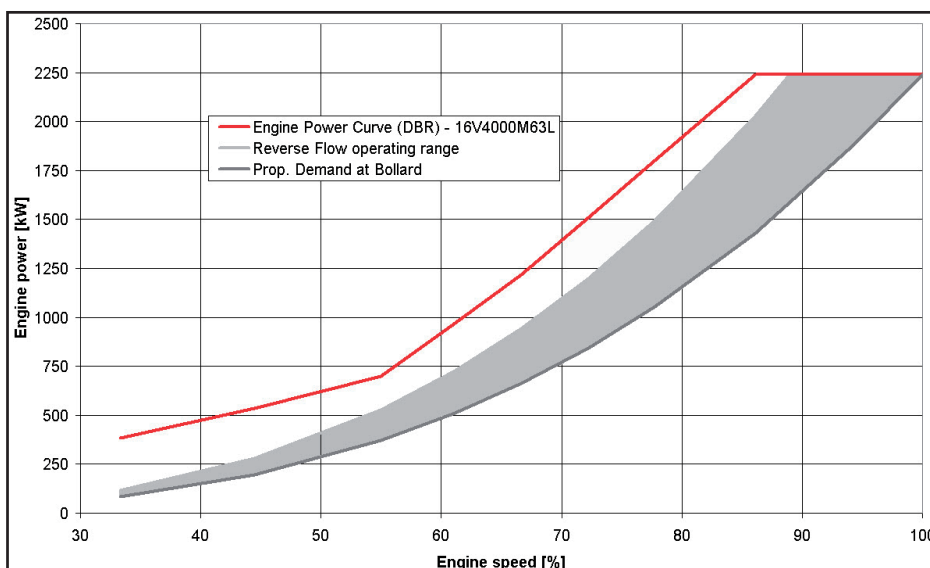

Figure 11: Engine power curves versus power demand curve reverse flow.

Influence of exhaust gas temperature

Generally speaking, when accelerating high-speed diesel propulsion engines, it is considered acceptable to have them capable of going from idle to rated engine speed in 15 seconds or less. This must be done with a minimum amount of visible emissions (black smoke). 'Cold exhaust gas temperature' has a

major influence on transient response in turbocharged diesel engines. Turbochargers use the remaining energy from hot exhaust gas (enthalpy) to drive a turbine that directly drives a compressor, which in turn builds up charge air pressure forcing more air to the cylinders. The higher the exhaust temperature is, the greater its potential energy for the turbochargers. Cold conditions mean in general that the engine has been idling or operating under light loads for a long period of time and thus the entire exhaust gas system is relatively cold, eg below 150 degrees C. Thus when the engine begins to accelerate, it takes longer for the turbochargers to become effective and the engine must spend a longer period of time running as a naturally aspirated engine.

In contrast, if the engine has been running at full power, the entire exhaust system including exhaust valves and manifolds can be nearly 650 degrees C. If the engine is brought to idle and then again commanded to full speed, the very hot exhaust gas system allows the turbochargers to become more effective sooner.

The implications are quite clear. If the given operation requires best possible engine response, it would be more advantageous for the operator to choose a zero speed drive orientation with slightly elevated engine load to control speed rather than bringing the engines to low idle.

3. CRITERIA/REQUIREMENTS ON MAIN PROPULSION ENGINES

Diesel engine selection criteria can be divided into the following groups:

- Corporate (ie company image and reputation);
- Sales and service support (ie global sales & service network, service quality, spare parts availability);
- Commercial (ie initial cost and life cycle costs);
- Technical product features.

Every individual customer and every project may have a unique ranking of the different criteria for selection of an engine make and model. Furthermore, in recent years, selection criteria have been reduced to engine availability rather than a detailed checklist of technical and commercial requirements. In the context of this paper we will concentrate on technical criteria related to the operation of ship assist tugs with up to 80 tonnes bollard pull.

Reliability and availability

These are considered as basic requirements, which should not be substituted by other criteria.

Fuel economy

With the typical operating profile of tugs it is essential that the diesel engine has a good efficiency/fuel economy particularly at light and medium loads. Furthermore, the load profiles show that it is important to consider the realistic engine operating point's power/speed. Values for

specific fuel consumption on the propeller curve n^3 may not be realistic for free running conditions.

Engine performance map

The pre-condition is that the engine delivers the required power for the specified bollard pull. What are the power reductions at higher ambient conditions? Eg ambient (combustion) air temperature 50 degrees C in tropical condition?

- Does the engine manufacturer allow unrestricted operation at the specified rated power?
- Does the engine offer sufficient torque margin from idle to rated speed to allow safe vessel manoeuvring also in reverse flow condition? (see *Figure 11 opposite*).

Some turbocharging techniques such as variable turbine geometry or sequential turbo charging offer improved torque margins compared with conventional turbocharged diesel engines. The torque margin from idle speed up to approximately 70 per cent of engine speed must be evaluated.

Emissions

Compliance with exhaust emission regulations is mandatory for commercial operators. Visible smoke at steady-state operation is no longer acceptable with modern diesel engines, and even normal acceleration is expected to be free of smoke in harbours or coastal areas.

Low load operation and load cycling

This has a significant impact on the service intervals and lifetime of a diesel engine, if the engine is not designed for such operating conditions. Critical aspects of low load operation are the precise control of the requested fuel quantity and the protection against cooling down to avoid incomplete combustion leading to formation of PM (soot) and HC emissions.

Load cycling has to be considered when defining turbocharger specifications and maintenance schedules. They also have impact on engine structural load due to uneven temperature distribution.

4. ENGINEERING TOOLS AND METHODOLOGY

Simulation

The efficient development of a high-performance, turbocharged, diesel engine demands the application of analytical methods and models. These models provide the inter-disciplinary basis for the analysis of complex interactive systems such as ship assist tug applications. The results provide competent aids for the optimisation of design parameters such as engine power, fuel consumption, emissions, as well as the systems dynamic behaviour. Modular calculation models were developed for disciplines such as thermodynamics, gas dynamics, hydrodynamics and control theory.

Thermodynamic/gas-dynamic engine model

To answer complex thermodynamic and gas-dynamic questions, engine models are created based on the conservation laws of mass, momentum and energy. Figure 12 shows a GT-Power model of the 16V4000M63L.¹⁰

The geometry of gas-carrying lines was shown based on CAD drawings even before a component was cast as hardware. The valve lift-dependent intake and exhaust valve flow cross-sections are recorded in tables. Turbines and compressors are described by means of performance maps. Starting from the injection rate, the combustion process inside the cylinder can be calculated by means of phenomenological models.¹¹

Such gas-dynamic models allow descriptions of the steady state engine behaviour and comparisons of different technologies from a very early development stage onwards.

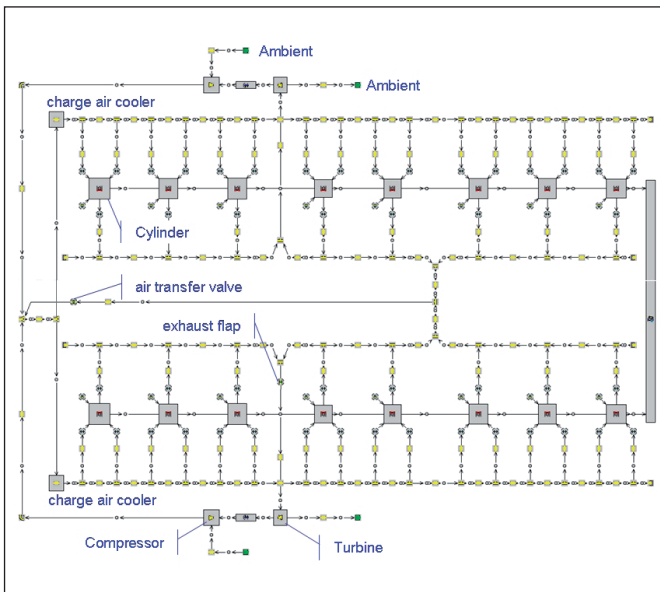

Figure 12: 16V4000M63, GT-Power model.

Engine-controller

For the description of transient propulsion conditions, the model must be supplemented by additional subsystems. In this respect, special attention must be given to the engine controller. Therefore a detailed model of MTU's Advanced Diesel Engine Controller, ADEC¹², was directly integrated into the engine model. As a result, the controller behaviour (dynamic of fuel injection, start of injection) but also activation of the exhaust flap (with sequential turbocharging), fuel limitation in case of deficient air etc, can be simulated very precisely.

Hydrodynamic ship-/propeller model

For the computation of complex procedures such as crash stop manoeuvre or reversal manoeuvre the hydrodynamic and mechanical reciprocal effect between hull, propeller and diesel engine must be considered.

Ship resistance is computed from key characteristics such as ship length, width, depth, displacement and speed. Power output and efficiency of the propeller are specified by the open water diagram. Both values depend on propeller speed and the rate of flow to the propeller. With a well-known propeller geometry the open water diagram can be calculated based on wing- and slipstream-theory¹³.

Overall system

The combination of the section models to one complete system now permits the calculation of complex transient processes. It was, for example, possible to prove that an increase of charge air pressure compensates the restricted combustion air exchange due to reduced inlet valve lift (Miller cycle, refer to section 5).

The calculation/measurement comparison displayed in Figure 13 shows the variation of key operating values over time. Acceleration is in line with the highly demanding bollard pull curve (refer to section 2). It is possible to recognise the very good acceleration characteristics of the engine as well as the high conformity of calculation and measurement.

NB: The calculations were carried out at an early development stage; the measurement was done on the test engine in a MTU test cell dynamometer.

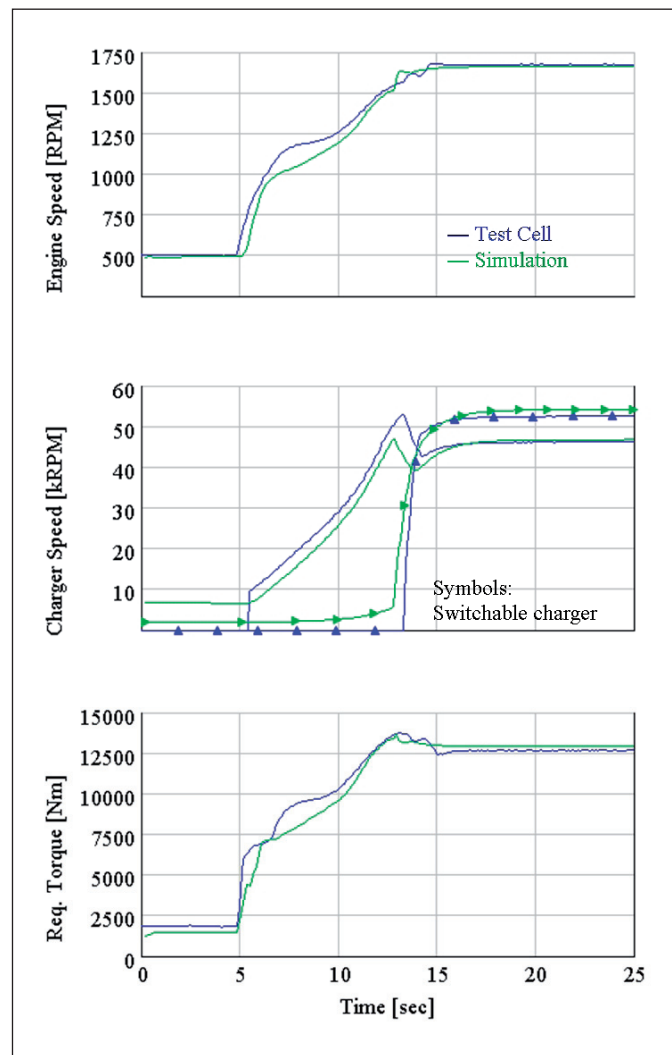

Figure 13: Engine acceleration – simulation and test.

Test bench

In the MTU development test cells, a number of engineering tools and methods are implemented to ensure that the engine being released will live up to the demands of the market and customer expectations. A list of such tools, as well as a broad description of their use, is given below. More detail, as well as the real benefit of their use to the final product, follows. None of the tools mentioned are exclusive to any one particular engine manufacturer.

- Governor interface;
- Instrumented test cell engine;
- Test cell + dynamometer;
- Vibration and noise measurements;
- Smoke opacity measurement;
- Emissions measurements.

Governor interface

Modern diesel engines are controlled electronically. The engineering interface to the governor (engine control unit ECU) is made possible with software via a CAN bus link.

The software, in MTU's case, Diasys, is a very powerful program that is used not only by the engineers developing the engine calibrations in the factory, but also by service personnel in the field. This software (with more limited access to key parameters) is even available for use by the end customer. Customers and service personnel primarily use the software for engine monitoring.

Of course, not all parameters are used in every application. Some are even intended for the expected future use of diesel engine exhaust after treatment. But the extensive monitoring capabilities allow service personnel and engineers to determine more precisely how well the engine is operating in the ship and to diagnose any engine trouble more quickly, should the need arise. For engineers developing the S4000 workboat engine calibrations in the factory, this software is the vehicle by which key parameters may be programmed in the engine. Engine power, engine rated speed, engine idle speed, acceleration and deceleration rates, levels of smoke control, alarm responses, ie engine shutdown for low oil pressure, are all programmed into ADEC via the Diasys interface.

Commissioning of pre-series engines is supported by engineers using Diasys, measuring and tuning engine parameters to the application's specific needs. Recorded data taken during commissioning helps to verify how accurate the earlier simulation and test bench program was and may be used in developing further calibrations.

Instrumented test cell engine

Naturally, one of the most critical components of developing an engine is the engine itself. The engines used in product development are normally quite close to the final product thanks to advances in analytic

technologies like Finite Element Analysis (FEA) and Computational Fluid Dynamics (CFD) as well as the effective use of electronic design software. The key difference between a normal production engine and an engine used for product development is that the development engine is equipped with a vastly greater array of sensors for data collection. This is needed in order that the engineers may ascertain whether or not all key engine systems are operating as designed throughout the entire operating envelope (all allowable engine power and speed under standard and extreme conditions). While analytical methods reduce the trial and error of such testing, only testing itself can prove that all components perform together as intended.

Test Cell – Dynamometer

The test cell is where much of the early development and validation work is carried out. Modern test cells enable engine manufacturers to operate the engine in a wide variety of simulated environments and engine loads. One of the key components of the test stand is the dynamometer or dyno. The dyno is a tool that allows the measurement of the engine's torque output. With engine speed and the known torque, one is able to calculate power. Engines of the size necessary to make 70+ bollard tones typically require a style of dyno called a water brake or hydraulic dyno. The dyno is filled with a variable amount of water. The engine then begins to circulate this water. As the water is circulating, the housing of the dyno attempts to rotate counter to the circulation of the water. The torque on the housing is then measured and calculated into torque output seen at the engine. *Figure 14* displays the principle of the water brake dyno.

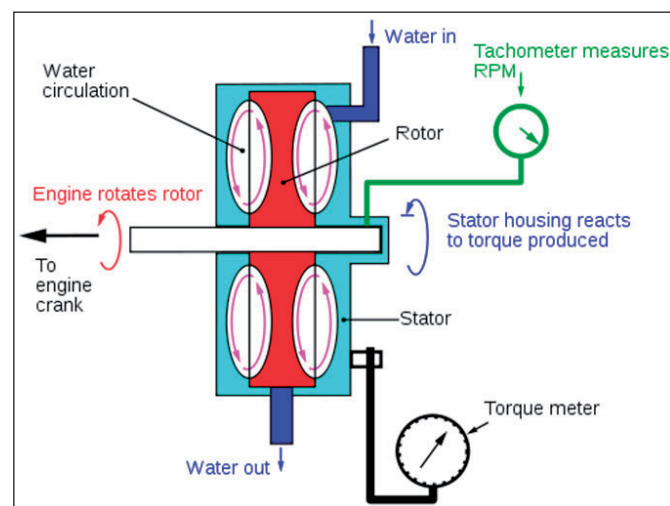

Figure 14: Test cell dynamometer with water brake.

The downside of this dyno is that they do not react instantaneously due to the fact that water must be pumped in and out to vary load. Most manoeuvres undergone by tugboats apply load (relatively) slowly compared to say that of an electric generator. For this reason, a well programmed water brake dyno is normally sufficient to simulate loads, both static and transient, seen on ship assist tugs and other workboat applications. If simulated instantaneous load changes

are required, then the water brake dyno may be coupled to an eddy current (or electric) dyno. In this case, the water brake absorbs some of the power and the electric dyno can apply instantaneous load changes. The two dynamometers must be used in tandem due to the fact that the eddy current dyno is normally not capable of handling full engine loads of the type installed in 70+ tonne BP tugboats (generally greater than 2500hp per engine on a two engine tug.)

During development, MTU engines, such as the S4000, spend thousands of hours undergoing durability testing as well as hundreds of transient tests simulating different manoeuvre and load scenarios. These tests are then compared against real world testing. For example, in *Figure 15* is an example from the dyno showing engine acceleration versus exhaust gas temperature. *Figure 16* is the same manoeuvre made during an earlier bollard pull test on the tugboat *Tijuana*.

Vibration measurements

Although all engine manufacturers go to great lengths to minimise vibration through engine design alone, the fact remains that all internal combustion engines produce vibration. During the development and testing of the S4000 workboat engine, hundreds of measurements were taken on external parts, such as fuel lines, brackets, pumps, turbochargers, etc. These measurements were made to ensure that all the parts mounted on the engine were sufficient and able to function without failure caused by vibration.

Of particular use in the design and construction (or repower) of a ship are the engine's structure borne and undamped exhaust noise data. The accuracy and availability of this data allows designers to properly select the correct damping materials for the engine room, addressing engine surface noise, and to select a best-fit exhaust silencer, addressing undamped exhaust

noise. It goes without saying that any reductions in engine noise and vibration directly translate to an improvement in the comfort of the crew manning the ship.

Emissions measurements

The need to meet worldwide emissions regulations, such as those from IMO Marpol or the United States EPA, is one of the biggest drivers for the development of new diesel engine technology. While there are some differences between the various regulations, they are all designed for the purpose of reducing nitrous oxides (NO_x) from diesel engine exhaust.

It is essential that accurate emission measurements be made while the engine calibrations are being developed. This ensures not only that the engine(s) sold will conform to any of the necessary regulations, but also that the engine is optimised as well as possible due to the possible heavy trade-off between fuel consumption and NO_x reduction.

Smoke opacity measurements

The amount of smoke considered acceptable varies from region to region and operator to operator. With experience, a good baseline is programmed into the engine, one that balances smoke reduction with performance and one that can be modified later based on further experience in a given application. The word experience is key because there is no current industry standard for setting the limits of a diesel engine's smoke, or, 'visible emissions'. There are, however, standards for measuring the density of diesel exhaust smoke, such as the Bosch number.

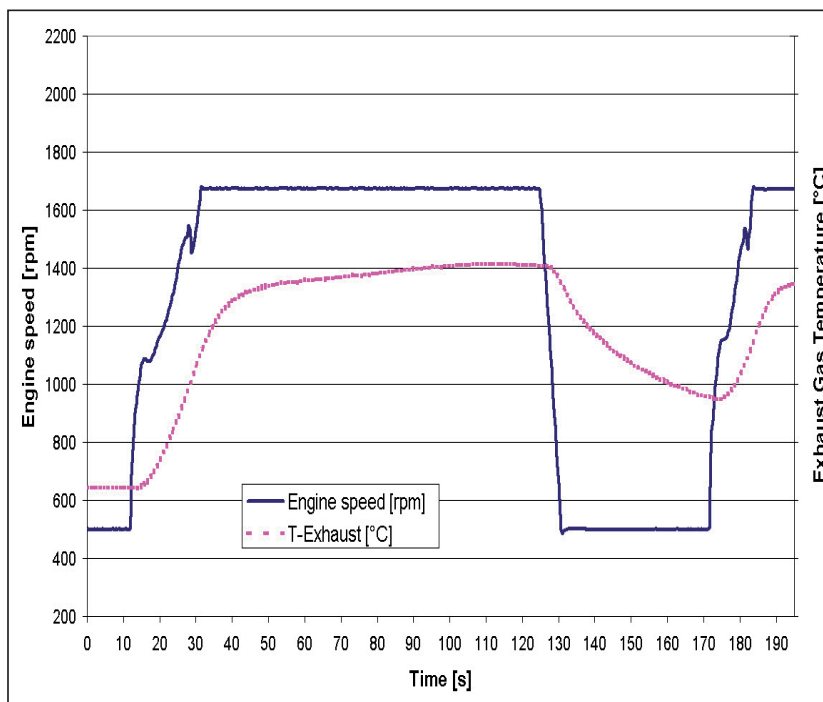

Figure 15: Test bench engine acceleration.

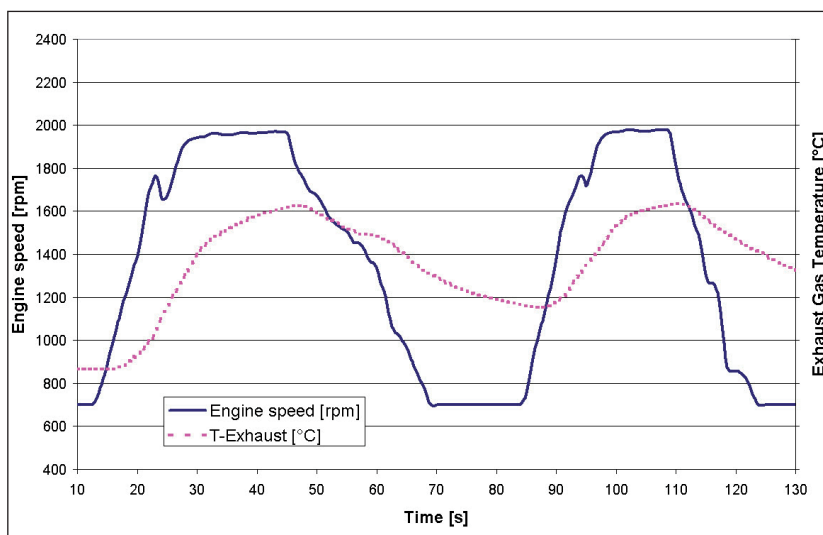

Figure 16: Bollard pull acceleration with tug *Tijuana*.

On the development test stand, the density of smoke coming from the exhaust is measured via an opacity meter. This device works by simply shooting a laser across the exhaust pipe. When a portion of the light from the laser is impeded from reaching the opposite sensor, the opacity meter reports back a value.

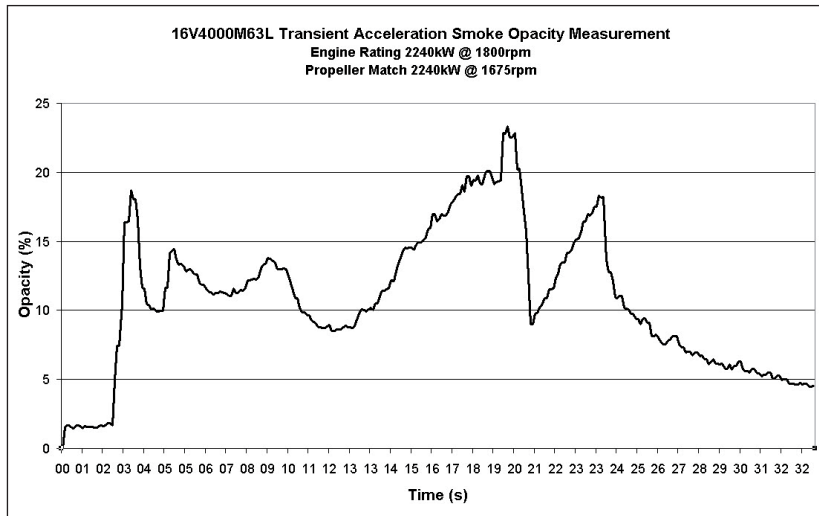

Figure 17: Exhaust opacity during acceleration test.

Figure 17 is an example from the output of the opacity meter while the engine was undergoing a bollard transient simulation from idle to full power. The scale on the y-axis goes to 100 per cent and, if achieved, means the engine is producing very dense black smoke. Generally speaking, values under 25 per cent are quite low and, again in the authors' experience, would not raise concern with operators.

5. ENGINE TECHNOLOGY AND FEATURES

Thermodynamic and mechanical concepts to fulfil the customer requirements and engineering targets include the optimisation of:

- Cylinder displacement;
- Valve timing ('Miller cycle');
- Turbo charging;
- Fuel injection;
- Engine cooling concept.

In order to reduce thermal and mechanical stress to the engine, the brake mean effective pressure (BMEP) was reduced compared to the predecessor engine. This was achieved by increasing the cylinder displacement by 17 per cent from 4.06 to 4.77 litres per cylinder. The increased displacement results in the need for a less demanding turbocharging system, leading to lower charge air peak temperature and consequently lower surface temperature. SOLAS requirements for surface temperature (max 220 degrees C) were achieved without the typically used fibre insulation material on the charge air cooler. The resulting mechanical advantages from reduced BMEP were converted into fuel consumption benefits and engine performance advantages such as broad torque characteristics. The idle torque was increased by 50 per cent comparing the 16V4000M63 with its predecessor M61.

The reduced mean effective pressure also allowed for an increased compression ratio without increasing engine stress via high peak cylinder pressure. The higher compression ratio (now 17:2) also leads to an improved engine (cold) start capability.

Different design studies for a workboat engine's ability to meet current and future emission regulations were compared and evaluated¹⁴. Among these, exhaust gas recirculation (EGR) and advanced valve timing (Miller) were the most favourable.

The advantages of valve timing technology as compared to EGR are:

- Minor design changes and no additional components;
- Conventional proven technology;
- Reduced engine heat loss.

Figure 18 describes the principle of the Miller cycle valve timing. The inlet valve closes earlier compared to conventional valve timing, which creates a lower temperature in the cylinder and thus a further reduction in the formation of NO_x.

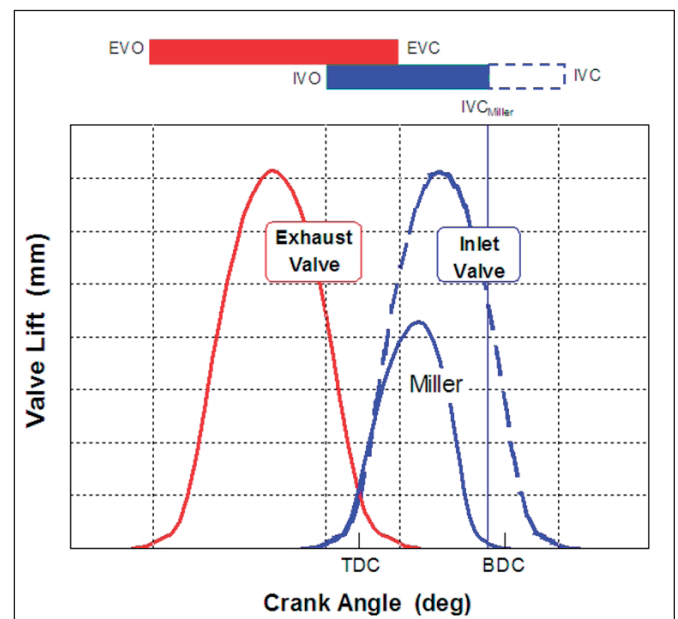

Figure 18: Principle of Miller cycle valve timing.

Meeting the legal NO_x emission limits without the Miller cycle (eg by means of retarding the combustion timing only) would have resulted in considerable fuel consumption penalties (see Figure 19 on next page). The new MTU workboat engine design and thermodynamic technology fulfil the demand for optimised fuel efficiencies both in the engines part load and full load operating ranges.

The charge air system, consisting of charge air pipes, turbochargers, and charge air cooler were pre-designed in an analytical study. The overall efficiency

of the combustion system depends substantially on the function of the charge air and exhaust system. Because of these influences the thermodynamic investigation had to consider all these systems together. Compressor and turbine characteristics and efficiencies were calculated and optimised in-house by means of computational fluid dynamics (CFD), thus resulting in an optimised charge air and exhaust gas system configuration.

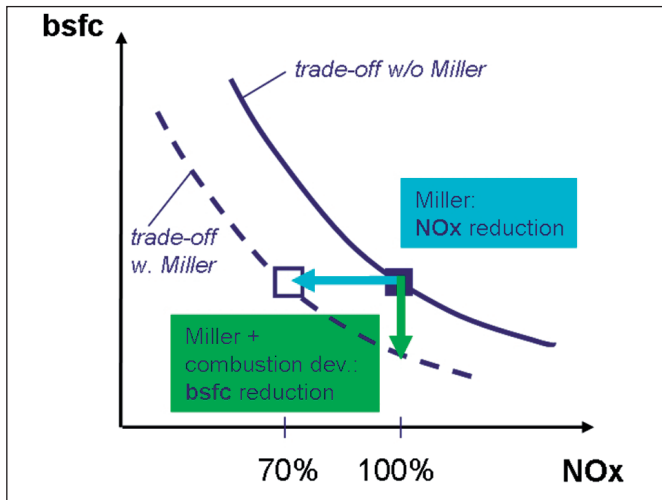

Figure 19: Trade of specific fuel consumption vs NO_x emission without and with Miller cycle.

The Series 4000 workboat engines use MTU ZR turbochargers combined with sequential turbo charging technology (see Figure 20), whereby the engine operates from idle to medium load with only one turbocharger and then up to rated load with an additional second turbocharger. The second turbocharger is switched on via an air flap and an exhaust flap. This technology results in a broad performance map, particularly at medium speed.

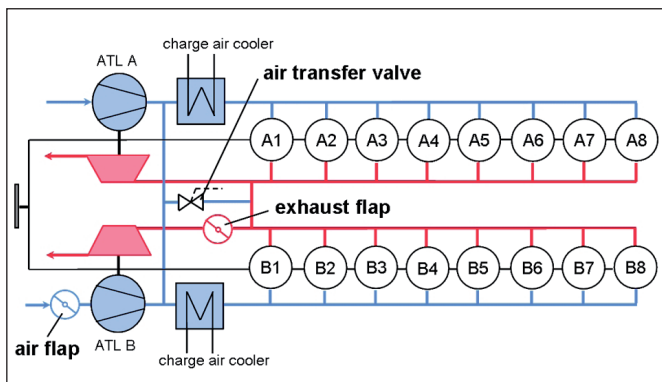

Figure 20: Principle of the single stage sequential turbo charging concept.

This turbocharging technology also offers significantly higher torque at part load and benefits in fuel consumption because the compressor operating range can be focused more closely on high efficiencies.

The Series 4000 Low Emission Advanced Design (LEAD) fuel injection system is the second generation of MTU's common rail system. The LEAD concept was

earlier introduced on other MTU heavy duty applications like rail and mining, assuring a proven and reliable system. Only a slight modification by means of an injection nozzle design such as flow rate, spray angle, and number of injection holes were made.

Engine control unit (ECU)

The latest generation of the Series 4000 workboat engine has the Advanced Diesel Electronic Controller (ADEC). ADEC manages all of the engine's critical functions such as the beginning of fuel injection, duration of injection, injection pressure, interpretation of engine sensor data, response to sensor alarms, etc. The use of the electronics with modern diesel engines is still, in the opinion of the authors, not fully embraced within the industry due to a perception that electronics equals complexity. But in fact, the intelligent use of electronics can indeed simplify the operation of the engines to the user.

One of the key benefits of an 'electronically controlled' engine is its ability to self-monitor. Parameters such as oil pressure, coolant temperature, engine speed and turbo charger speed are crucial to engine protection. But it is not only the monitoring of the parameters that are of benefit to the user, but also the response to an alarm. Modern electronics allow a variety of programmable responses to alarms from only a warning signal (level 1) over power reduction (level 2) to complete engine shutdown.

This type of logic can be used on a variety of sensors for primary component protection, ie in case of clogged box coolers or high exhaust back pressure. For example, when the exhaust temperature before the turbochargers is monitored and if limits are exceeded, engine power is automatically reduced to protect the turbo(s) from excessive exhaust gas temperature. Overrides for power reduction or automatic shutdown are programmable and must be in accordance with classification/operator requirements.

Features such as these simplify the operation of the engine and enable captains to devote more attention to navigation of the ship that may otherwise have been used in protection of the engines.

Another beneficial ADEC function for applications like ship assist tugs is the so-called half engine mode, where 50 per cent of the cylinders are cut out during idle operation. With this half engine mode activated, the remaining cylinders have higher load, which leads to a cleaner combustion situation.

6. THE OUTLOOK

Diesel electric propulsion systems and hybrid systems in tugboats aim for a reduction in operating costs and emissions by reducing inefficient low load operation of the main diesel engines. The load profiles and the average load factors (all below 25 per cent) of the references listed earlier show great potential for

efficiency improvement. However, a detailed case study considering all efficiency losses in energy transformation is mandatory. Energy storage devices, eg batteries, offer the possibility for 'silent' or 'emission-free' low load operation as well as for peak shaving.

Hybrid systems can further improve the responsiveness and acceleration potential of a tug, in particular at low engine speed where the turbocharged diesel engine acts as a naturally aspirated engine. Considering an electric power of 20 per cent of the installed diesel rated power, the additional torque at idle is approximately 50 per cent of the diesel engine's low end torque. Furthermore, this constant torque provided by the electric motor is available from zero speed (with a decoupled diesel engine) up to approximately two-thirds of the rated speed of the diesel engine, depending on the design parameters. Above the design speed of the electric motor it provides constant power available for additional boosting.

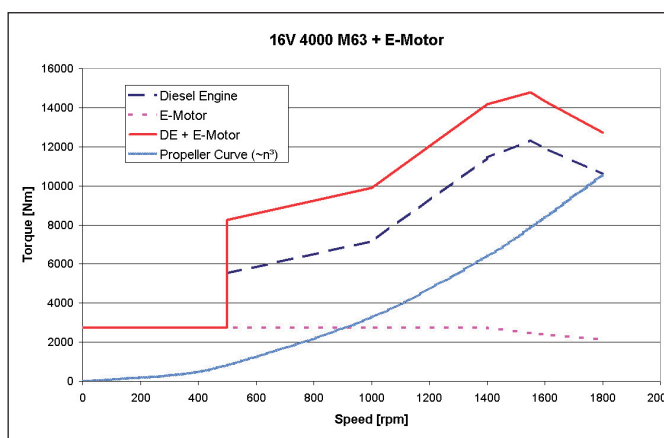

Figure 21: Torque characteristics of 2000kW diesel engine and 400kW electric motor.

However, the energy storage requires significant volume and weight. Therefore it is strongly recommended to optimise their design according to the expected load profiles. For boosting only energy storage with a high power capability, super-capacitors, or high-power batteries, for example, are preferred; high-energy storage is necessary, for example, for emission-free operation over longer periods.

To what extent the downsizing of installed diesel engine power could be possible by adding battery power will certainly be a topic for discussion amongst experts in the industry, including naval architects, classification societies, operators and propulsion system suppliers.

CONCLUSION

The authors are convinced that key criteria in tug and workboat operation, in particular life cycle costs and reliability, can be met without penalties in operational safety or emissions by means of advanced diesel engine technologies. An understanding of the customer demands for the specific workboat segment is a mandatory prerequisite in determining adequate

technologies. Sophisticated engineering methods, tools and validation programmes help to minimise development risk, time and, consequently, costs for engine manufacturers and end customers.

In particular, the interaction between different engine and combustion features, ie an extreme Miller valve timing affecting the load acceptance at low load, requires a well-balanced combination of engine key technologies.

Ship assist tug boats, with conventional diesel mechanical, diesel-electric or hybrid systems, are of particular interest when evaluating future emission reduction possibilities and limitations due to their duty cycle with a high amount of low loads and a high degree of transient operation.

REFERENCES

- ¹ Moran staff writer (nd), *Moran: Corporate Overview*, retrieved on February 2nd, 2010 from <http://www.morantug.com/corporateoverview.asp>
- ² Seaspan staff writer (nd), *Seaspan: About Us*, retrieved on February 2nd, 2010 from http://www.seaspan.com/_global/_content/aboutus.htm
- ³ Foss writer (nd), *Foss: About Us*, retrieved on February 2nd, 2010 from <http://www.foss.com/about.html>
- ⁴ Website Remolques Unidos, <http://www.gruporemolquesunidos.com>
- ⁵ Interview, Ken Houle, director, Technical Services, Atlantic Detroit Diesel-Allison, Piscataway, NJ, January 17th, 2009.
- ⁶ Interview, Dave Beardsley, vice president Construction & Repair Department, Moran Towing Corporation, New Canaan, CT, January 19th, 2010.
- ⁷ Interview, Glenn Burdett, sales manager, Cullen Diesel Power Ltd, Surrey, BC, January 12th, 2010.
- ⁸ Interview, Allan Turner, mechanical engineer, Robert Allan Ltd, Vancouver, BC, December 14th, 2009.
- ⁹ Interview, Ken Harford, president, Robert Allan Ltd, Vancouver, BC, December 11th, 2009.
- ¹⁰ GT-Power User's Manual, Version 7.0, Gamma Technologies, Inc, 601 Oakmont Lane, Suite 220 Westmont, IL 60559 USA-Westmont.
- ¹¹ Yoshizaki, T, Nishida, K, Hiroyasu, H, *Approach to Low Nox and Smoke Emission by Using Phenomenological Simulation*, SAE 930612, 1993.
- ¹² O Schnelle, J, Remele, U, Kosiedowski, H, Weidele, *Das neue MTU Motormanagement ADEC, MTZ 11-2007*.
- ¹³ John S Carlton, *Marine propellers and propulsion*, Butterworth-Heinemann, Oxford 1994.
- ¹⁴ N Vesper, R Speetzen, G Glowacki, *Development of the S4000 workboat engine*, Ironmen, CIMAC Congress, 2010.

Figures 1a and 1b: Load profile Seaspan Falcon - 2x 12V4000M60.

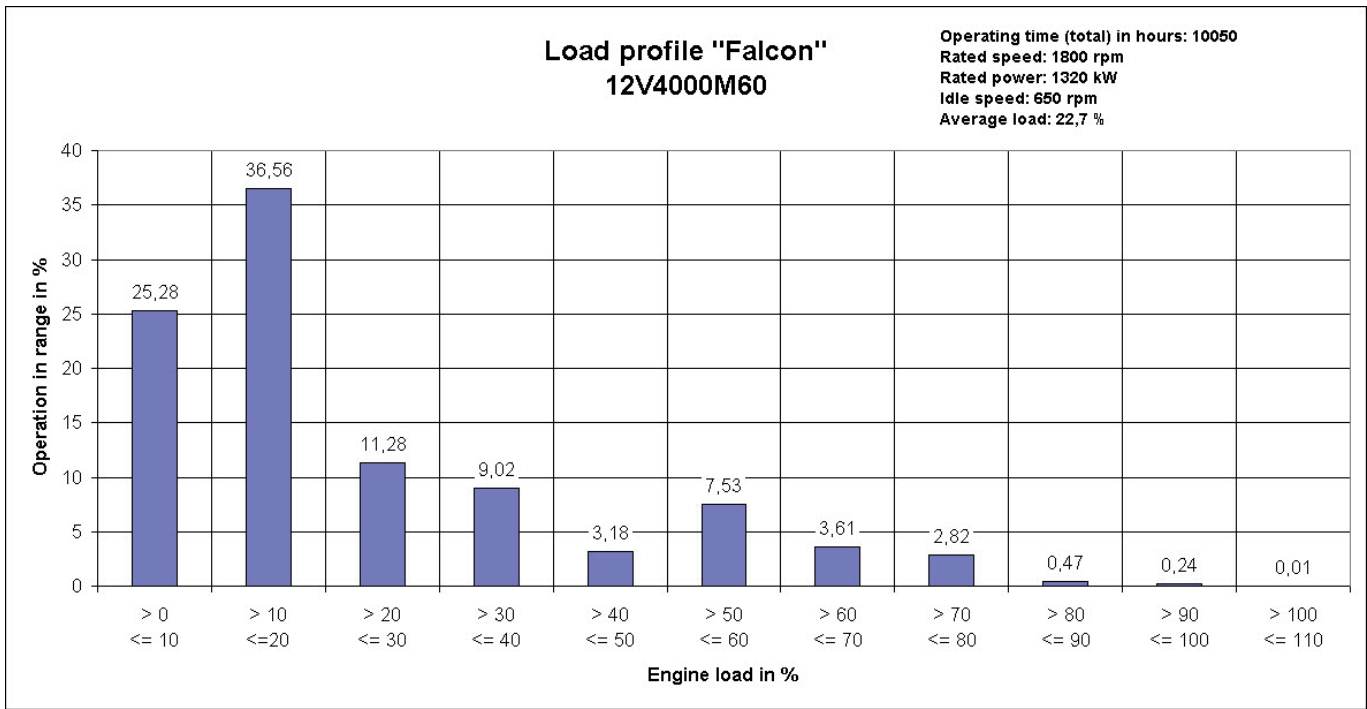

rpm \ kW		>350	>500	>650	>800	>950	>1100	>1250	>1400	>1550	>1700	>1850
		<= 500	<= 650	<= 800	<= 950	<= 1100	<= 1250	<= 1400	<= 1550	<= 1700	<= 1850	<= 2000
1350	1425											
1275	1350											
1200	1275		scale							0,01%	0,04%	
1125	1200		from:	to:								
1050	1125		0,01%	1,00%								
975	1050		1,00%	3,00%							1,5%	
900	975		3,00%	5,00%	0,04				0,02%		1,0%	
825	900		more than 5%									
750	825										1,7%	
675	750							0,04%				
600	675										5,1%	
525	600					0,03%	0,03%			1,5%	1,0%	
450	525											
375	450											
300	375				0,01%							
225	300											
150	225					1,4%	3,1%	1,6%				
75	150	0,01%	0,08%	0,22%	2,6%	5,1%	1,1%					
0	75		23,3%	24,8%	2,3%	1,1%						

Figures 2a and 2b: Load profile Rusa Vehintidos - 2x 16V4000M61.

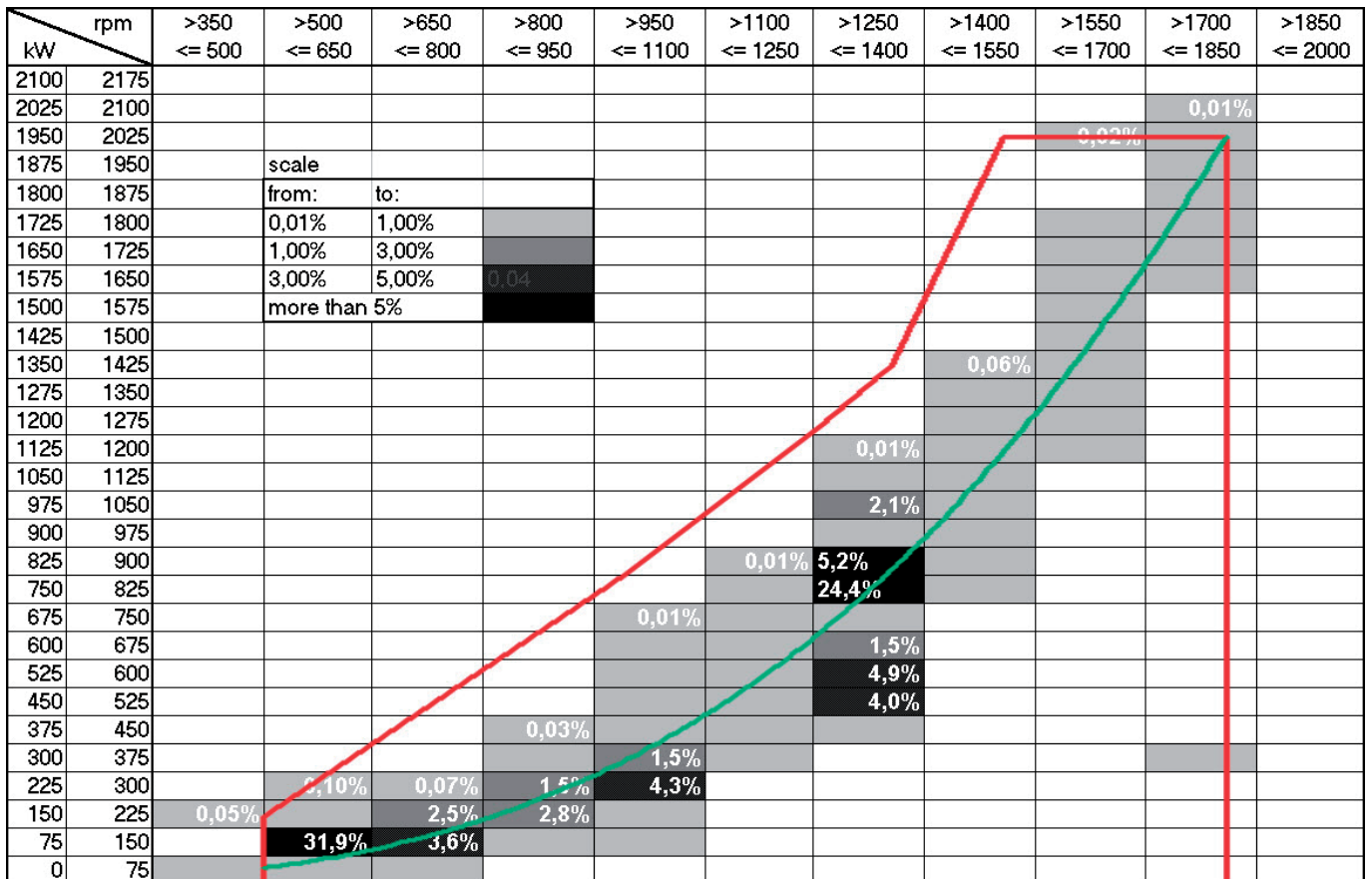
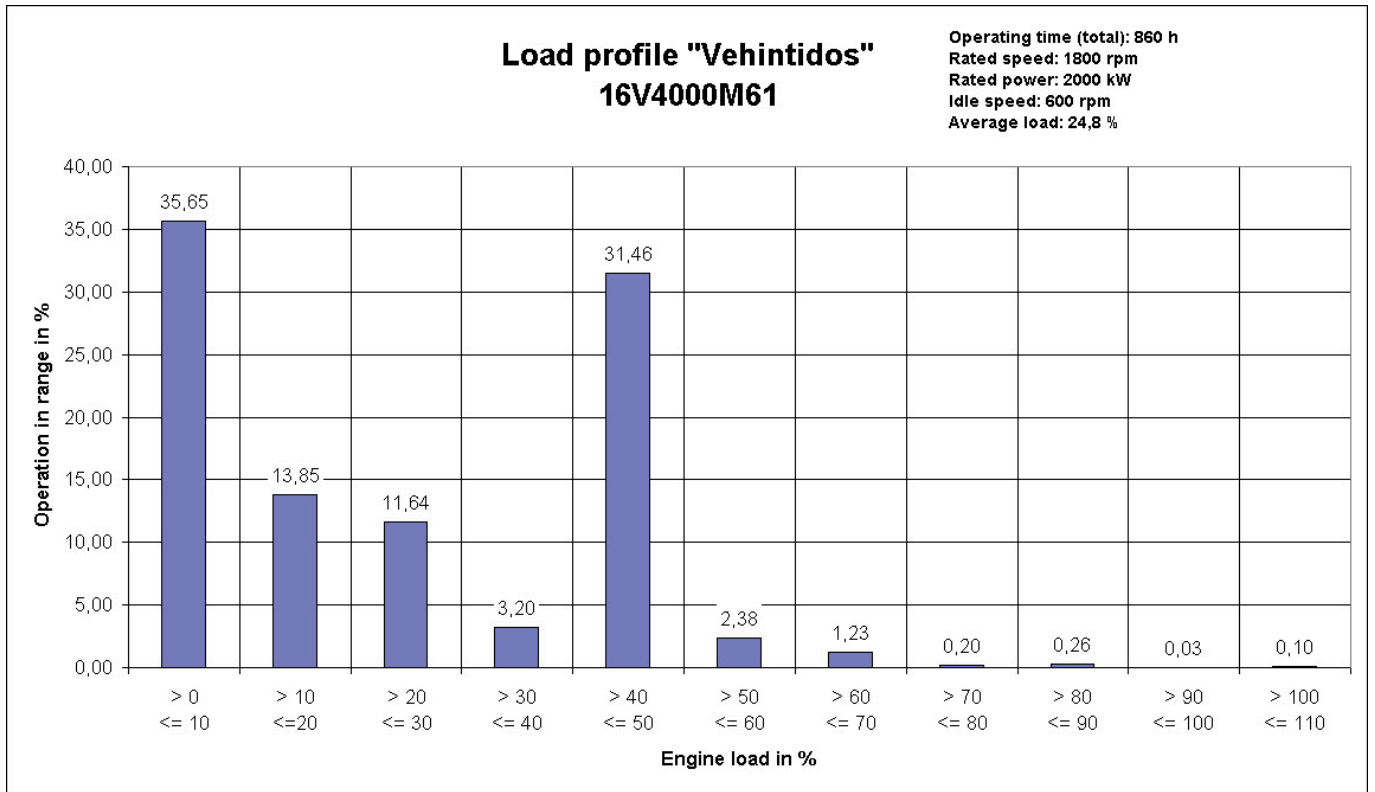

Figures 4a and 4b: Load profile Moran Shiny V - 2x 16V4000M61.

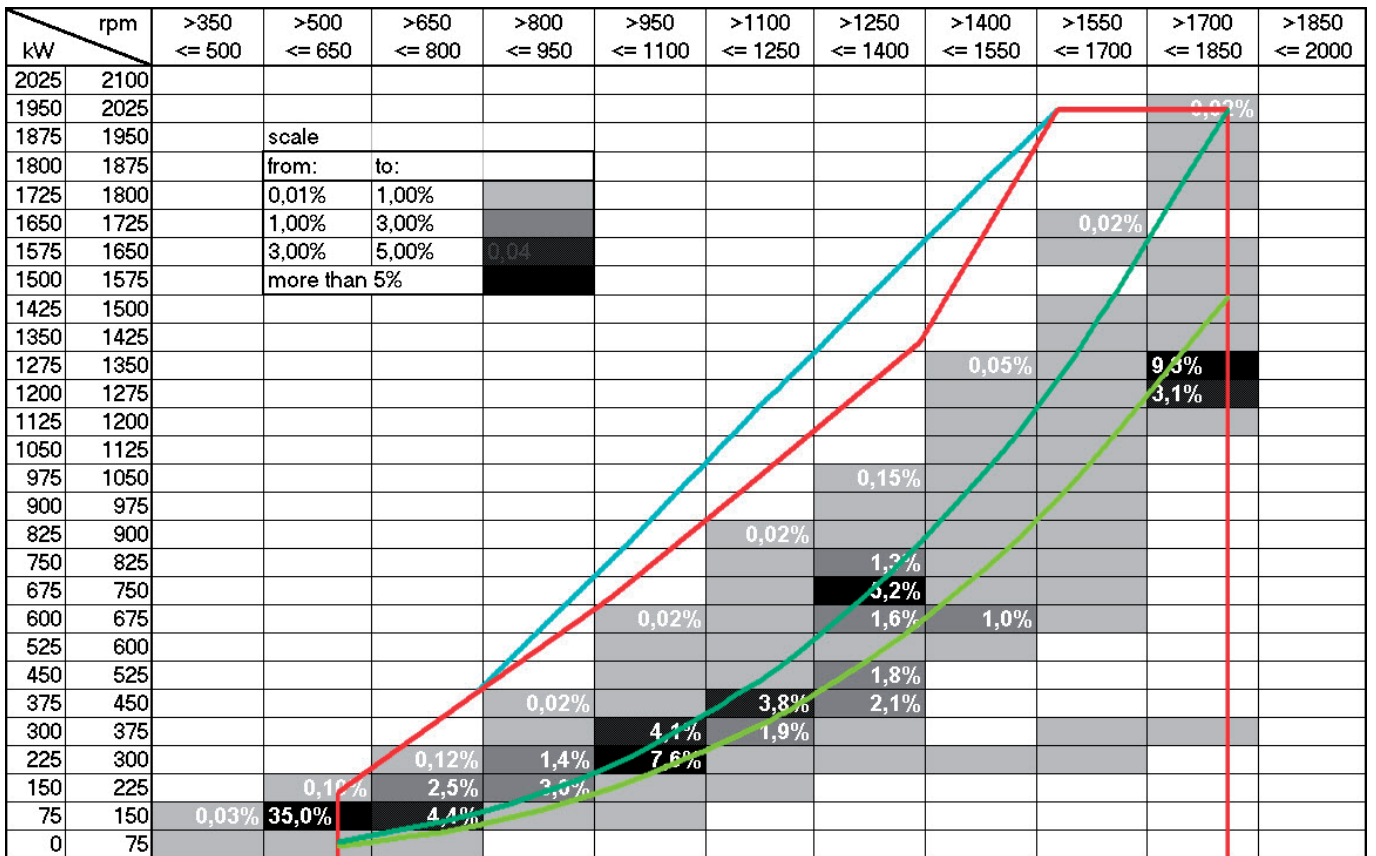
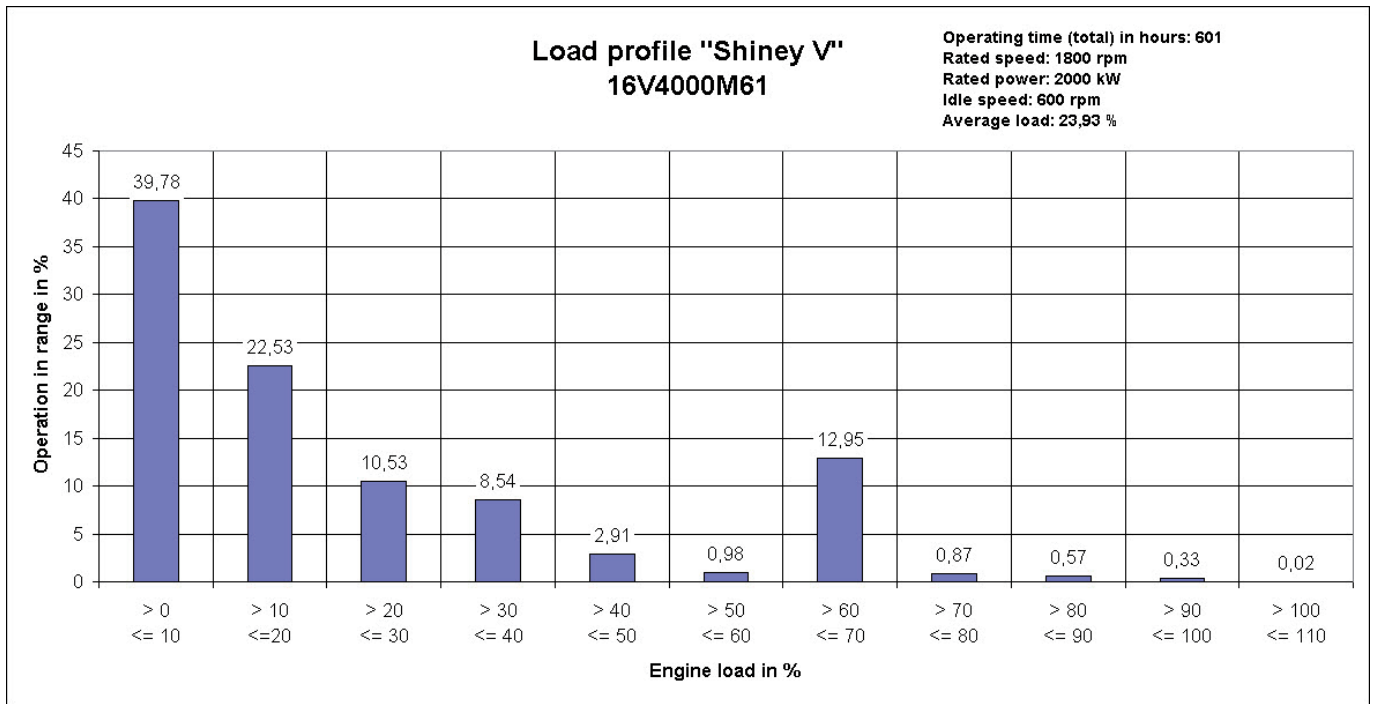

Figures 5a and 5b: Load profile Foss America - 2x 16V4000M71.

